



ELECTRIC LIFT TRUCKS
WALKIE TRUCKS
PLD/FBD/SBW Series



Increasing the efficiency of warehouse distribution

Electric power steering and AC control system for smooth, quiet operation

*Simple to operate, even for beginners.
What's more, it's designed to be safe and eco-friendly.*



A wide variety of models are available to suit your work environment.

PLD Series

1000kg	1500kg	2000kg	3000kg
Pedestrian Type Travel Speed 4.5km/h	Sub Step Type Travel Speed 4.5km/h		Center Rider Type Travel Speed 7km/h
 Middle Mount Handle	 Middle Mount Handle (Priority to Pedestrian Use)	 Top Mount Handle (Priority to Rider Use)	 Top Mount Handle

FBD Series			SBW Series	
700kg	900kg	1000kg	700kg	900kg
 Single mast Less than 1.5 m	 Two stage mast 1.5 m and higher	 Two stage mast 1.5 m and higher	 Single mast Less than 1.55 m	 Two stage mast 1.55 m and higher

* See page 8 for data on mast extension and rated capacities.

The comfortable operation of the Walkie Lift contributes to a more enjoyable work environment.



Steering handle with electric power steering

Surprisingly light and pleasantly easy to grip

Featuring the electric power steering, the Walkie Lift can be operated with little effort thanks to the steering handle's convenient position and short arm. This configuration ensures easy lifting and lowering as well as steering of loads. Moreover, the non-slip handle grip can be grasped firmly for sure operation.

AC inverter control ensures smooth start and acceleration

Even a beginner can operate the Walkie Lift like a pro.

Precise inching is possible thanks to inverter control. This innovation reduces the impact on the load and the operator while increasing work efficiency.

Eco-friendly energy-saving design (with accelerator-off power regeneration)

The Walkie Lift is equipped with an accelerator-off regeneration function that naturally brakes the truck when the speed control knob is returned to the neutral position during travel. In addition to providing smooth braking, it recovers electric energy. This eco-friendly design helps to minimize electric power consumption.

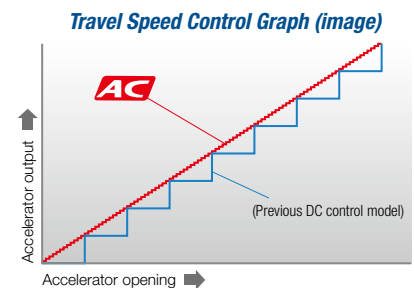

An excellent combination of durability and economy

Total AC contributes to reduced maintenance costs.

The new AC motor and inverter for traveling achieves unprecedented smoothness while reducing maintenance costs.

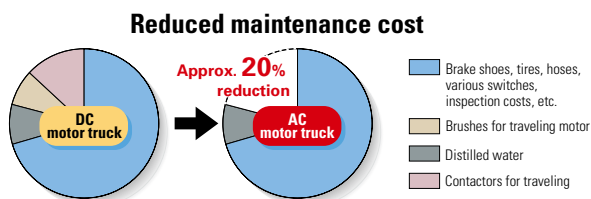

Battery indicator for clear display of remaining battery capacity

The indicator, provided as standard equipment, allows the operator to check the remaining battery capacity at a glance.



Equipped with a durable and long-lasting battery designed for industrial vehicles.

The Walkie Lift is equipped with an industrial vehicle battery that provides ample margin for hours of operation. An economy model is also available for light-duty use.

Equipped with reliable safety features for operator protection

Safety button to protect the operator

The safety button mounted at the top of the handle reverses the truck direction to prevent the operator from being caught between the truck and wall.



Dual position brake

The electromagnetic brake is activated by placing the handle in the vertical and horizontal positions. Simply letting go of the handle returns the powerfully spring-loaded handle to a brake position.

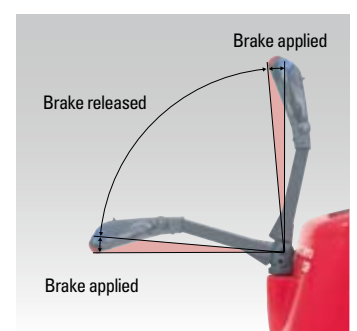

Walkie **Low Lift**

PLD Series

High-performance low lift with AC control meets the needs of today's warehouse logistics.



Photo: PLD15-70-A10

The electric power steering provides for operation with a light touch, even when handling heavy loads. The Walkie type offers wide-ranging utility, as anyone can operate it with ease.

Tight turning radius

With a minimum turning radius of only 1,405 mm, this compact truck can handle very tight turns.*

As a convenient low-lift truck, it is easy to handle and exhibits excellent maneuverability even in confined spaces.

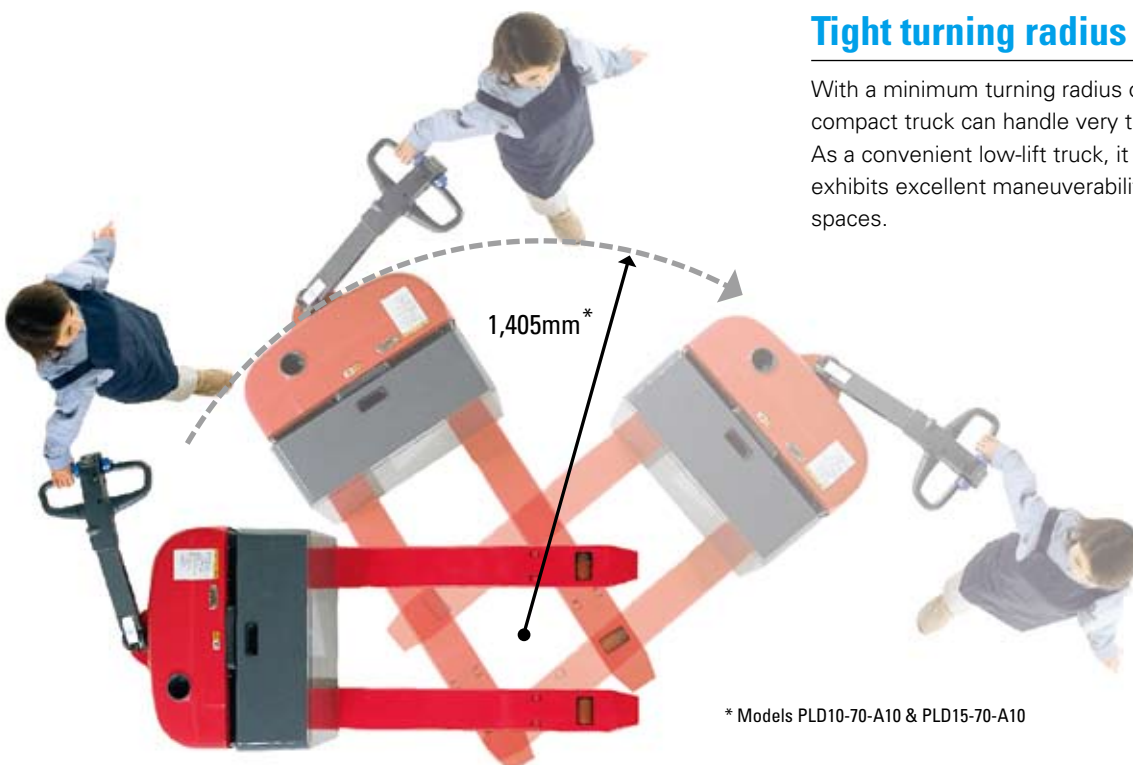

* Models PLD10-70-A10 & PLD15-70-A10

Low fork height for easier pallet insertion

The minimum fork height is 65 mm. This size is ideal for inserting into low-height pallets.

Note: PLD20/30 : 83 mm

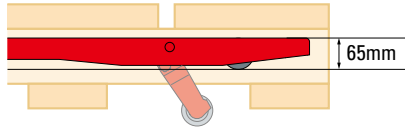

The 65-mm specification accommodates narrow pallets.
Compatible models: PLD10/15-70, PLD10/15S-70 & PLD10/15R-70

Toe guard protects operator's feet.

The toe guard provides secure foot protection by preventing the operator's shoe from slipping beneath the lift truck. It also reduces damage to the truck body and walls of the structure due to misoperation.



Easier picking operations in large-scale logistic centers

Because picking operations involve traveling, a walking-type truck can be very inefficient in a large warehouse. For this reason, we provide both sub-step and center-rider type to our variation. The highly mobile low lift design supports rapid development of logistics centers.



Center-rider type

This ride-on model excels at performing rapid material handling and picking operations.



Sub-step type

This easy ride-on model is ideal for long hours of material handling over longer distances.



* Optional side guard available

Several sizes available. Choose the model that best meets your needs.

Choose the appropriate fork size (mm).

Fork outside width	Code	D	C	B	A
	1.0t/1.5t	510	560	610	660
	2.0t/3.0t			555	680

Fork inside width	Code	D	C	B	A
	1.0t/1.5t	210	260	310	360
	2.0t/3.0t		—	205	330

Fork length	Code	07	09	10	12	13	15
	1.0t/1.5t	762	915	1068	1220	1372	1525
	2.0t/3.0t	—	915	1068	1220	1372	1525

Standard Optional

See specification sheet for details.

Walkie High Lift



Photo: FBD7-70-150
[Single mast]

Photo: FBD10-70-250
[Two stage mast]

FBD Series

700-kg	FBD7-70
900-kg	FBD9-70
1000-kg	FBD10-70

Apply to double face pallets.

Counterbalanced type with expanded capabilities

Simple enough for anyone to operate

It features a functional arrangement of a one-touch butterfly-type speed control knob as well as a warning horn, lift lever, and other functions. It is well designed for easy operation by all.

Equipped with a tilting mast as standard equipment. (optional on FBD7 & FBD9 models)

Lifting loads to higher levels with the forks can be hazardous if the forks are held horizontally. With the FBD Series, the mast can be tilted backward for greater security and prevention of toppled loads.

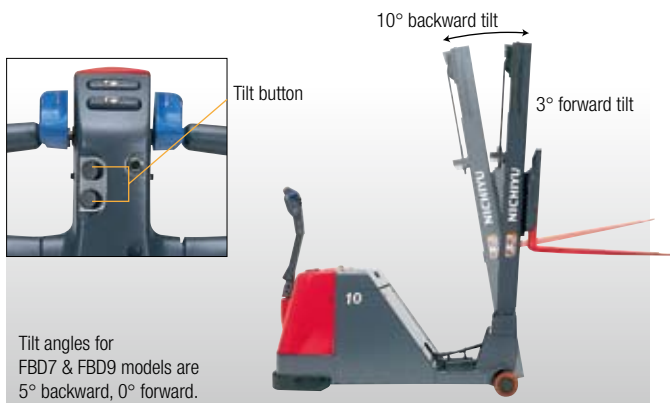

Inversion forks

The forks can be rotated rearward to facilitate entry in elevators and other confined areas. This innovation makes the FBD Series suitable for use in multilevel warehouses.



Easy stacking in temporary storage spaces

This lift truck is well suited to shipping and receiving in temporary storage spaces. Such spaces are typically small and crowded with many pallets. The FBD Series easily stacks items two levels high, ensuring the effective use of temporary storage spaces.





Photo: SBW9-70-150
[Single mast]

SBW Series

700-kg **SBW7-70**
900-kg **SBW9-70**
Apply to double face pallets.

This highly maneuverable straddle leg model boasts a tight turning radius.

Outstanding turning performance

This easy, compact, and convenient lift truck handles exceptionally tight turns. The minimum turning radius is only 1,430 mm,* ensuring good maneuverability even in confined spaces.

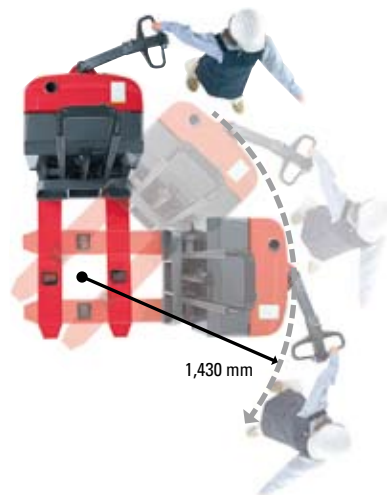

* Model SBW7. Turning radius of Model SBW9 is 1,500 mm.

This lightweight model can be operated on upper floors with confidence.

This compact and lightweight lift truck is the ideal choice for use on upper floors. What's more, it won't overload your freight elevator.

* Service weight of Model SBW7-70-150 is 715 kg.
Service weight of Model SBW9-70-150 is 720 kg.

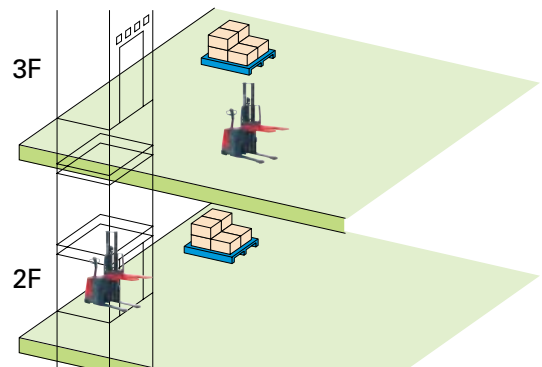

Lorry with entire roll box pallets

If your lorry lacks a lifter, products that have been picked inside the factory or delivery center must be reloaded to the lorry, which is highly inefficient. The SBW Series, however, is capable of loading an entire roll box pallet onto a truck.



Choose the mast height that meets your lifting needs.

Both single mast and two stage mast models are available. Choose from the seven models of FBD Series and three models of SBW Series with two stage masts.

Rated capacities

Model	Mast	Single mast								
		150	200	230	250	270	300	330	350	400
FBD7	700	700	700	700	700	650	600	550	500	—
FBD9	900	900	900	900	900	830	770	700	630	—
FBD10	1000	1000	1000	1000	1000	950	900	850	800	600
SBW7	700	700	700	700						
SBW9	900	900	900	900						

* Load center is LC5000 mm for Model FBD10, LC4000 mm for other models.

Option & Application

The Nichiyu Walkie series offers the following options and is designed to meet the needs of your specific application.

- Cold Storage Application
- Hour Meter
- Back Buzzer
- Chime
- Rotating Beacon Lamp

Forward and rearward travel with the Walkie Series

Note that the orientation of the forks differs in the various models. Keep the following in mind when choosing optional equipment.

Low Lift Type

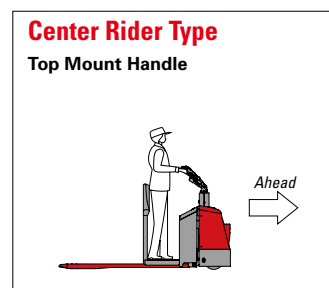
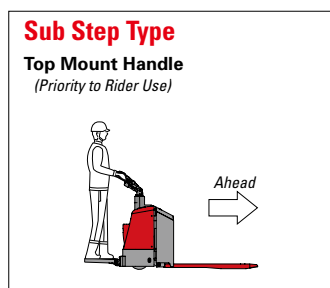
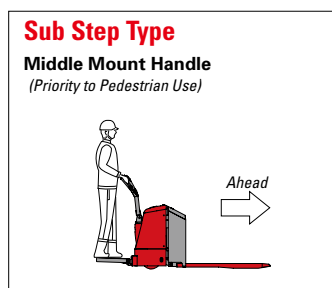
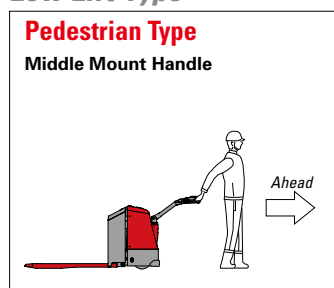

High Lift Type

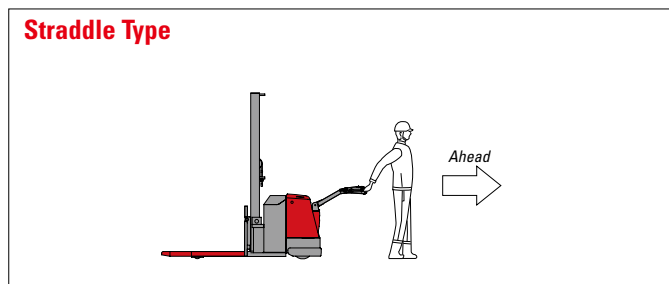
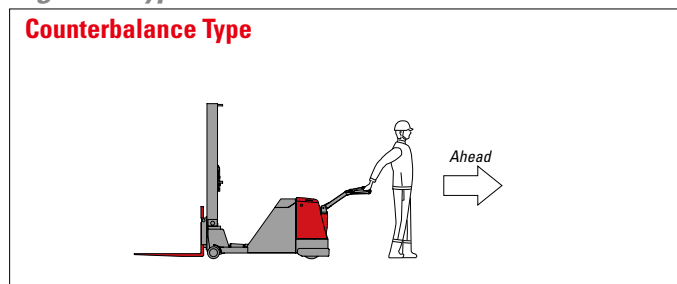

All specifications have been determined according to Nichiyu's terms and conditions.
Specifications are subject to change without notice in the interests of product improvement.

NICHIYU

Nippon Yusoki Co., Ltd.

1-1, 2-Chome, Higashikotari, Nagaokakyo-shi, Kyoto 617-8585 JAPAN
Tel: +81-(0)75-956-8622 Fax: +81-(0)75-955-0480 URL: <http://www.nichiyunet.co.jp/en>

CAT No.OSD090/N70-1 Printed in Japan 5000/0903(SK)